

INN150EQ032A

1. General description

GaN-on-Silicon enhancement mode high-electron-mobility-transistor (HEMT) in En-FCQFN with 4.0 mm x 6.0 mm package size.

2. Features

- GaN-on-Silicon E-mode HEMT technology
- Industry Application
- Very low gate charge
- Ultra-low on resistance
- Very small footprint

3. Applications

- High frequency DC-DC converter
- Solar Systems optimizers and microinverters
- PD Charger and PSU Synchronous Rectification
- Telecom Power Supply
- Motor driver

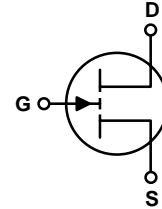

Top View

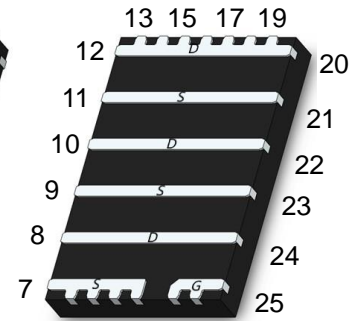

Bottom View

4. Key performance parameters

Table 1 Key performance parameters at $T_J = 25\text{ }^\circ\text{C}$

Parameter	Value	Unit
$V_{DS,max}$	150	V
$R_{DS(on),max}$ @ $V_{GS} = 5\text{ V}$	3.9	m Ω
$Q_{G,typ}$ @ $V_{DS} = 75\text{ V}$	20	nC
$I_{DS,Pulse}(T_J = 25\text{ }^\circ\text{C})$	260	A
Q_{OSS} @ $V_{DS} = 75\text{ V}$	130	nC

5. Pin information

Table 2 Pin information

Pin	Pin description	Pin function
1,2,25	Gate	Driver Gate
3-7,9,11,21,23	Source	Source
8,10,12-20,22,24	Drain	Power Drain

Table 3 Ordering information

Type/Ordering Code	Package	Product Code
INN150EQ032A	En-FCQFN 4X6	M06

Table of contents

- 1. General description 1**
- 2. Features 1**
- 3. Applications..... 1**
- 4. Key performance parameters..... 1**
- 5. Pin information 1**
- 6. Maximum ratings..... 3**
- 7. Thermal characteristics..... 4**
- 8. Electric characteristics 5**
- 9. Electric characteristics diagrams 7**
- 10.Package outlines 12**
- 11.Reel information..... 13**
- 12.Land Pattern 14**
- 13.Revision history 15**

6. Maximum ratings

at $T_J = 25\text{ }^\circ\text{C}$ unless otherwise specified.

Exceeding the maximum ratings may destroy the device. For further information, contact Innoscience sales office.

Table 4 Maximum ratings

SYMBOL	PARAMETER	MAX	UNIT
V_{DS}	Drain-to-Source Voltage (Continuous)	150	V
$V_{DS(tr)}$	Drain-to-Source Voltage ¹ ($V_{GS} = 0\text{ V}$, 1h total time, $T_A = T_{JMAX}$)	180	V
I_D	Continuous current ($V_{GS} = 5\text{ V}$, $T_C = 25\text{ }^\circ\text{C}$, $R_{\theta JC} = 0.24\text{ }^\circ\text{C/W}$)	252	A
	Continuous current ($V_{GS} = 5\text{ V}$, $T_C = 100\text{ }^\circ\text{C}$, $R_{\theta JC} = 0.24\text{ }^\circ\text{C/W}$)	159	A
	Continuous current ($V_{GS} = 5\text{ V}$, $T_A = 25\text{ }^\circ\text{C}$, $R_{\theta JA} = 56.63\text{ }^\circ\text{C/W}$)	16.4	A
	Pulsed ($T_J = 25\text{ }^\circ\text{C}$, $T_{Pulse} = 100\text{ }\mu\text{s}$)	260	A
V_{GS}	Gate-to-Source Voltage	6	V
	Gate-to-Source Voltage	-4	V
T_J	Operating Temperature	-40 to 150	$^\circ\text{C}$
T_{STG}	Storage Temperature	-40 to 150	$^\circ\text{C}$

Note:

1. Provided as measure of robustness under abnormal operating conditions and not recommended for normal operation;

7. Thermal characteristics

Table 5 Thermal characteristics

SYMBOL	PARAMETER	TYP	UNIT	Note/Test Condition
$R_{\theta JC}$	Thermal Resistance, Junction to Case	0.24	°C/W	-
$R_{\theta JB}$	Thermal Resistance, Junction to Board	1.31	°C/W	-
$R_{\theta JA}$	Thermal Resistance, Junction to Ambient ²	56.63	°C/W	-
T_{sold}	Maximum reflow soldering temperature	260	°C	MSL3

Note:

- $R_{\theta JA}$ is determined with the device mounted on one square inch of copper pad, single layer 2 oz copper on FR4 board.

8. Electric characteristics

at $T_J = 25\text{ }^\circ\text{C}$, unless specified otherwise

Table 6 Static characteristics

SYMBOL	PARAMETER	MIN	TYP	MAX	UNIT	TEST CONDITIONS
I_{DSS}	Drain Source Leakage	-	2	150	μA	$V_{GS} = 0\text{ V}, V_{DS} = 150\text{ V}$
I_{GSS}	Gate-to-Source Forward Leakage	-	2	100	μA	$V_{GS} = 5\text{ V}$
	Gate-to-Source Forward Leakage	-	6	1000	μA	$V_{GS} = 6\text{ V}$
	Gate-to-Source Reverse Leakage	-	0.1	100	μA	$V_{GS} = -4\text{ V}$
$V_{GS(TH)}$	Gate Threshold Voltage	0.8	1.1	2.1	V	$V_{DS} = V_{GS}, I_D = 12\text{ mA}$
$R_{DS(on)}$	Drain-Source On-state Resistance ³	-	3.2	3.9	$\text{m}\Omega$	$V_{GS} = 5\text{ V}, I_D = 30\text{ A}$
V_{SD}	Source-Drain Forward Voltage	-	1.5	-	V	$I_S = 5\text{ A}, V_{GS} = 0\text{ V}$

Note:

- $R_{DS(on)}$ is measured without prior drain bias or switching stress.

Table 7 Dynamic characteristics⁴

SYMBOL	PARAMETER	MIN	TYP	MAX	UNIT	TEST CONDITIONS
C _{ISS}	Input Capacitance	-	2200	-	pF	V _{GS} = 0 V, V _{DS} = 75 V
C _{OSS}	Output Capacitance	-	900	-		V _{GS} = 0 V, V _{DS} = 75 V
C _{RSS}	Reverse Transfer Capacitance	-	10.5	-		V _{GS} = 0 V, V _{DS} = 75 V
C _{OSS(ER)}	Energy Related C _{OSS}	-	1300	-		V _{GS} = 0 V, V _{DS} = 0 V to 75 V
C _{OSS(TR)}	Time Related C _{OSS}	-	1700	-		V _{GS} = 0 V, V _{DS} = 0 V to 75 V
R _G	Gate resistance	-	2	-	Ω	f = 5MHz, open drain
Q _G	Total Gate Charge	-	20	-	nC	V _{GS} = 5 V, V _{DS} = 75 V, I _D =30 A
Q _{GS}	Gate to Source Charge	-	5	-		V _{DS} = 75 V, I _D =30 A
Q _{GD}	Gate to Drain Charge	-	3.5	-		V _{DS} = 75 V, I _D =30 A
Q _{G(TH)}	Gate Charge at Threshold	-	3	-		V _{DS} = 75 V, I _D =30 A
Q _{OSS}	Output Charge	-	130	-		V _{GS} = 0 V, V _{DS} = 75 V

Note:

4. Guaranteed by design.

9. Electric characteristics diagrams

at $T_J = 25^\circ\text{C}$, unless specified otherwise

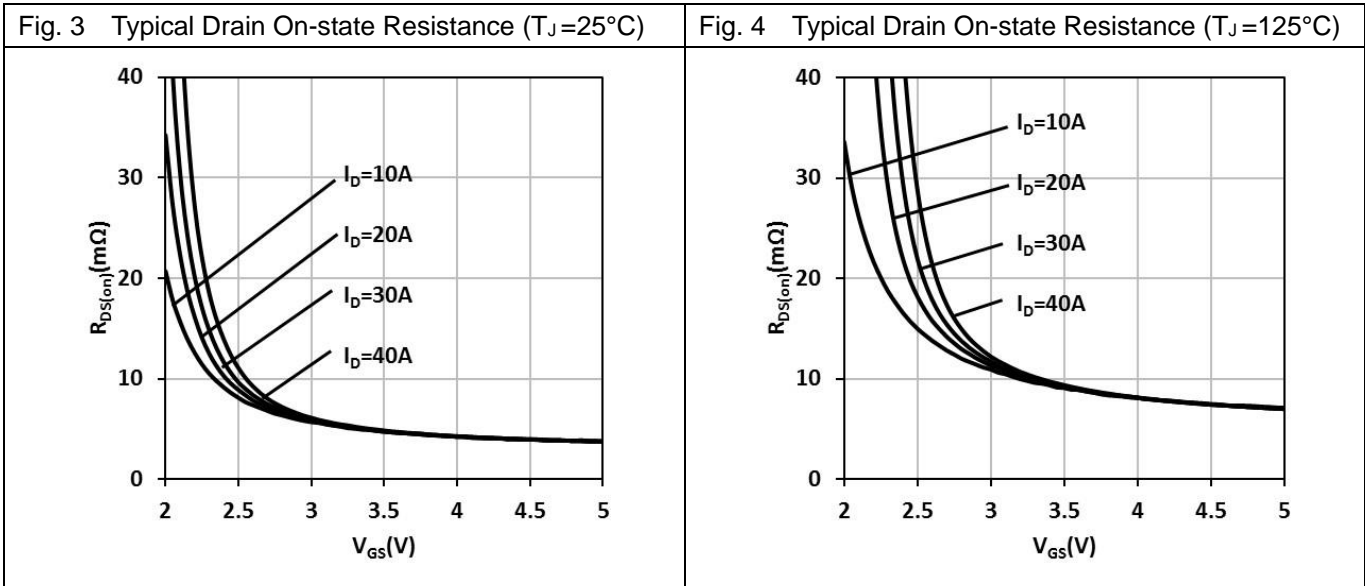
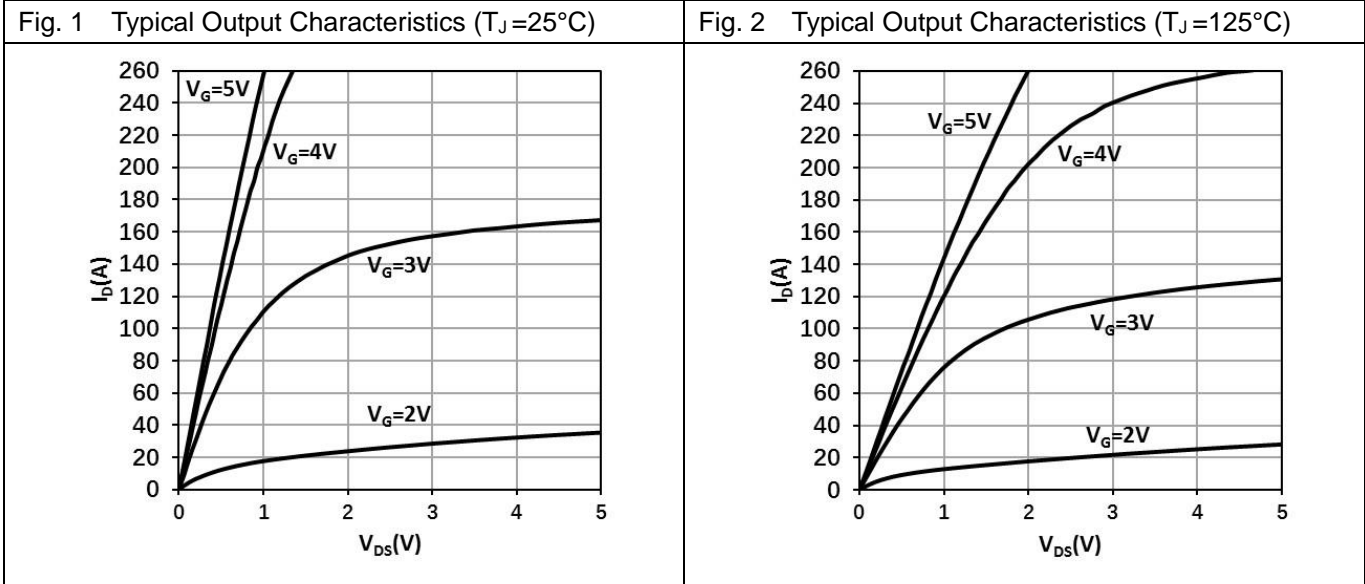

Fig. 5 Normalized On-State Resistance vs. Temp.

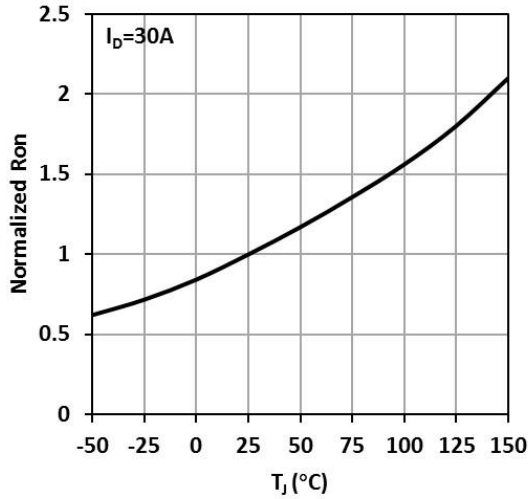

Fig. 6 Typical Transfer Characteristics

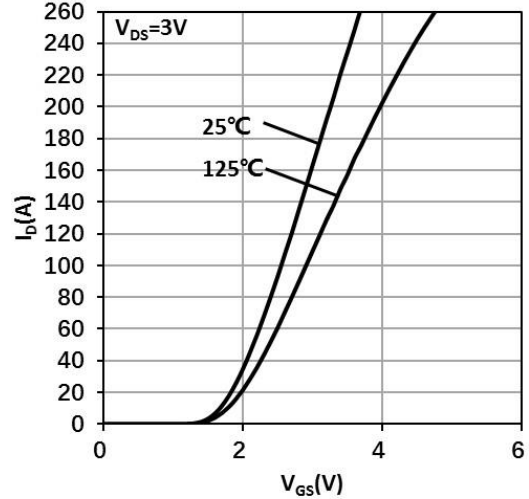

Fig. 7 Typ. Reverse Drain-Source Characteristics ($V_{GS} \leq 0, T_J = 25^\circ\text{C}$)

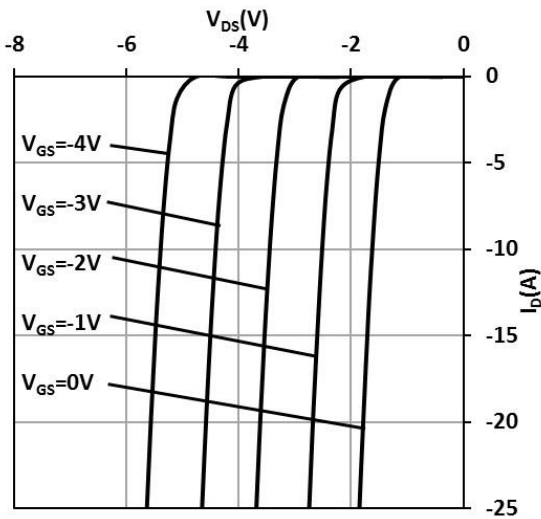

Fig. 8 Typ. Reverse Drain-Source Characteristics ($V_{GS} \geq 0, T_J = 25^\circ\text{C}$)

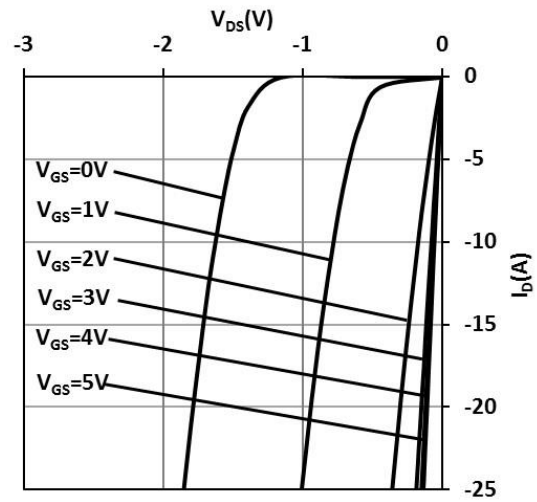

Fig. 9 Typ. Reverse Drain-Source Characteristics ($V_{GS} \leq 0$, $T_J = 125^\circ\text{C}$)

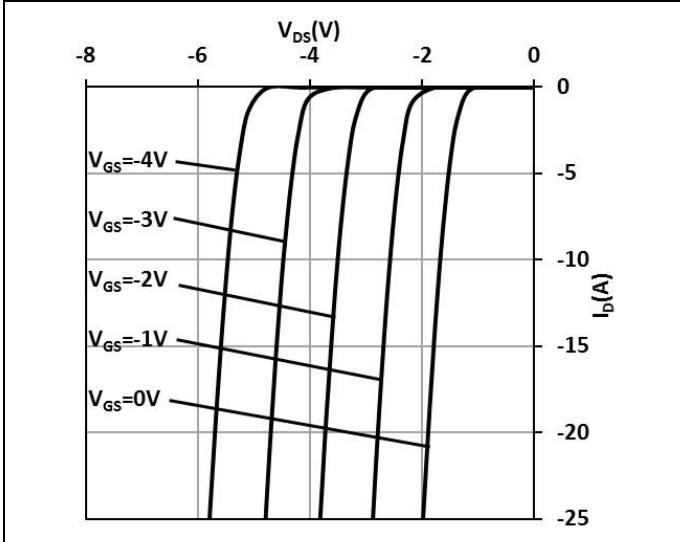

Fig. 10 Typ. Reverse Drain-Source Characteristics ($V_{GS} \geq 0$, $T_J = 125^\circ\text{C}$)

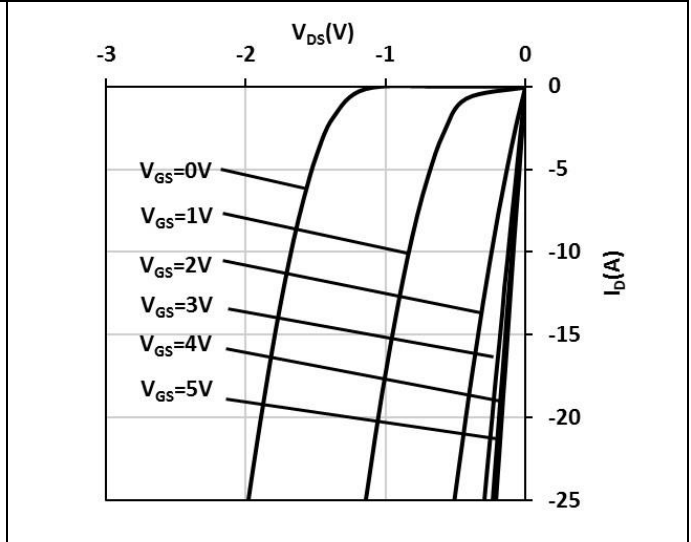

Fig. 11 Typ. Capacitances Characteristics

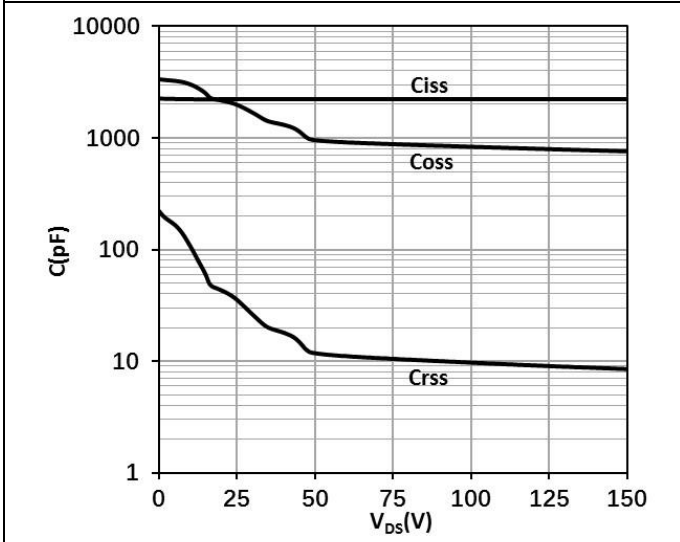

Fig. 12 Typ. Gate Charge

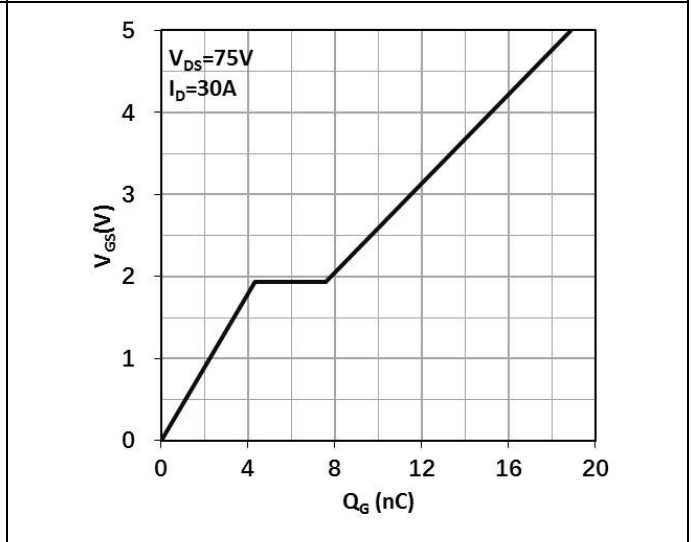

Fig. 13 Normalized Threshold Voltage vs. Temp.

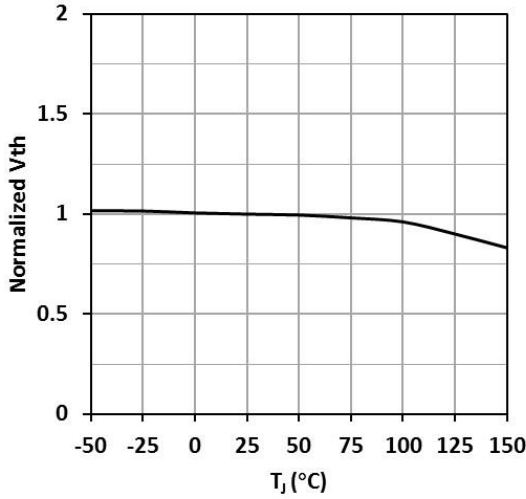

Fig. 14 Output Charge

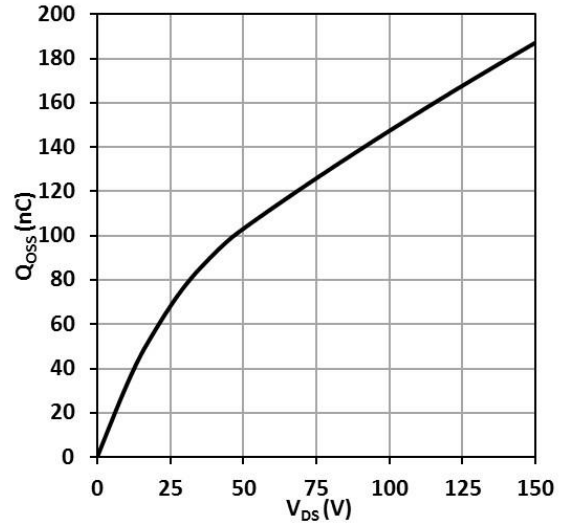

Fig. 15 Output Capacitance Stored Energy

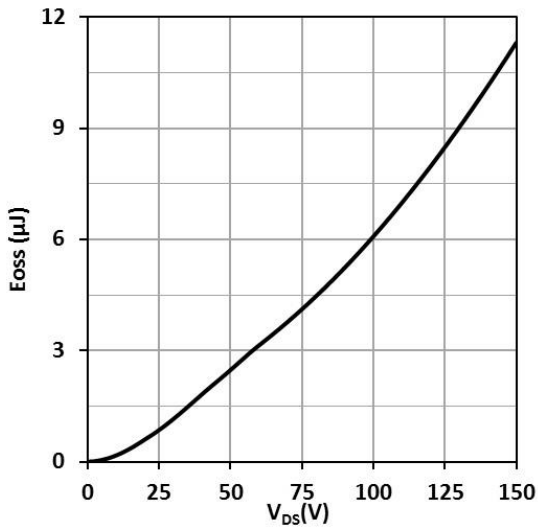

Fig. 16 Power Dissipation

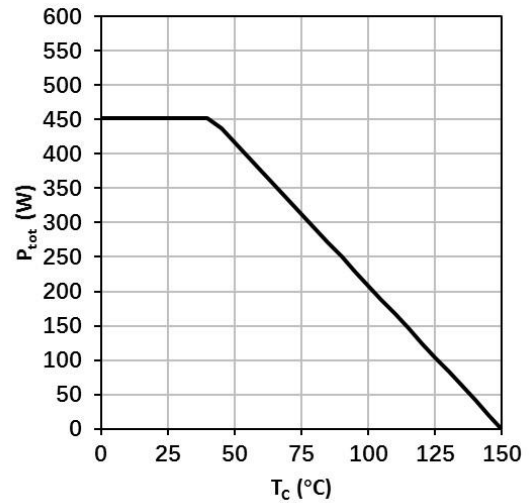

Fig. 17 Safe Operating Area

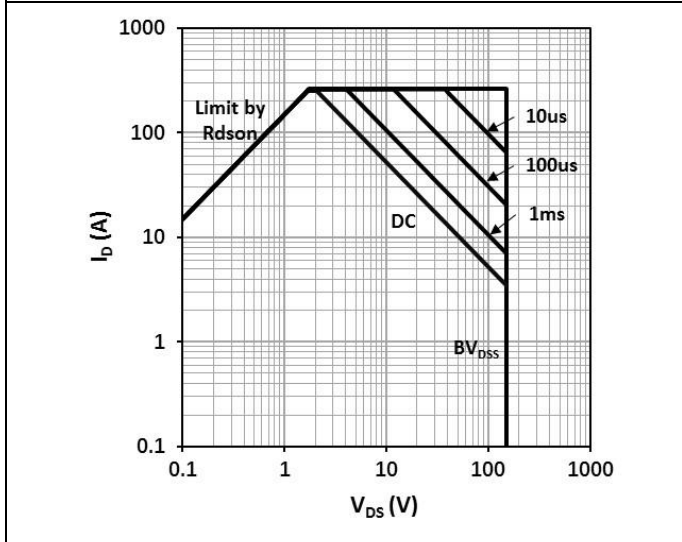
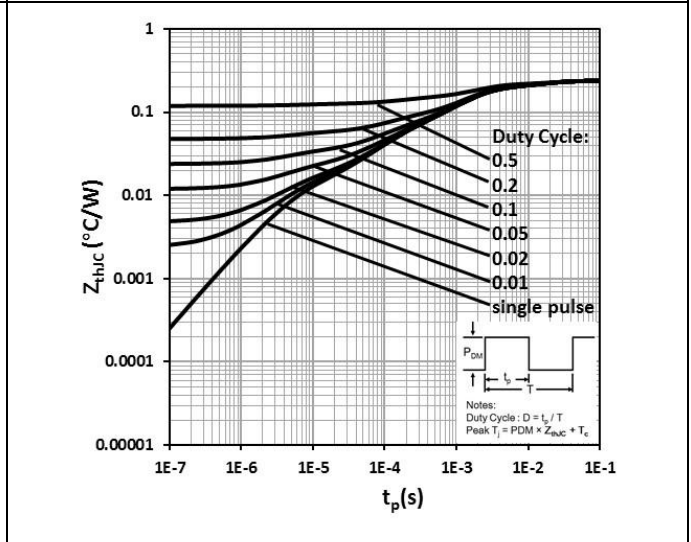
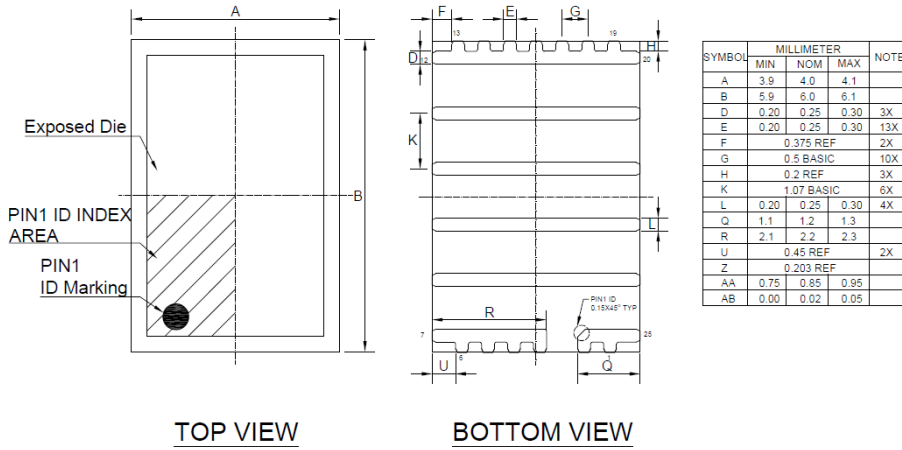

Fig. 18 Max. Transient Thermal Impedance



10. Package outlines

Package Reference



NOTE:

- 1) ALL DIMENSIONS ARE IN MILLIMETERS.
- 2) LEAD COPLANARITY SHALL BE 0.08 MILLIMETERS MAX.
- 3) JEDEC REFERENCE IS MO-220.
- 4) DRAWING IS NOT TO SCALE.

PIN configuration

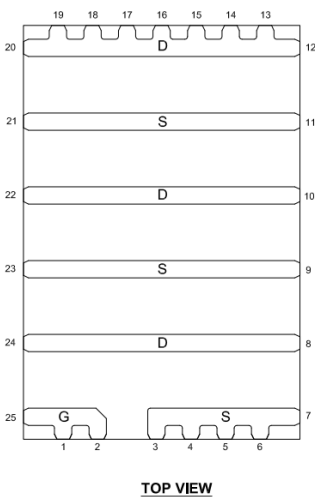

Marking Reference

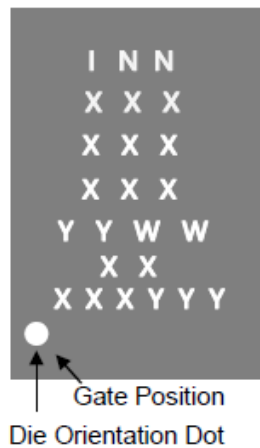

Row	Description	Example
Row1	Company name	INN
Row2	Product code	XXX
Row3	Lot Code	XXX
Row4		XXX
Row5	Date code	YYWW
Row6	Wafer ID	XX
Row7	Location ID	XXXYYY

11. Reel information

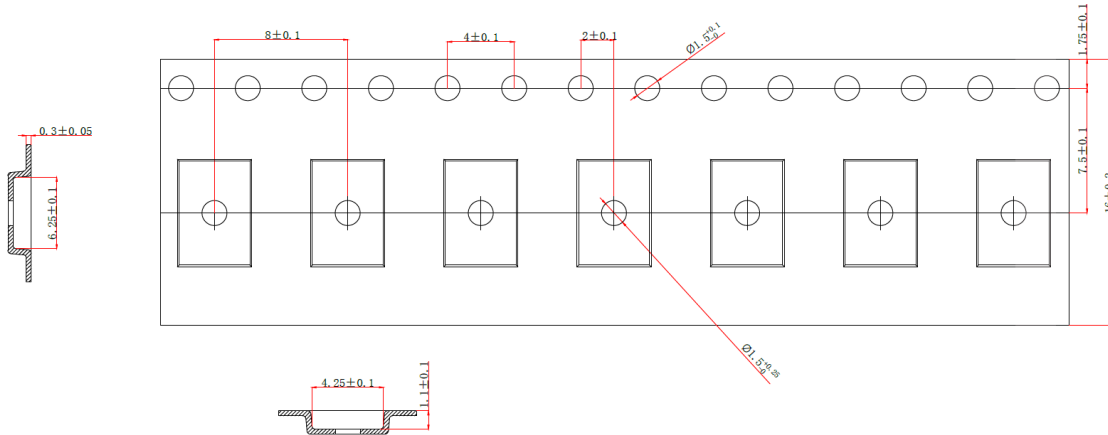

NOTES:

1. CARRIER TAPE COLOR: BLACK.
2. COVER TAPE WIDTH: 13.3±0.10.
3. COVER TAPE COLOR: TRANSPARENT.
4. 10 SPROCKET HOLE PITCH CUMULATIVE TOLERANCE ±0.20 MAX.
5. CAMBER NOT TO EXCEED 1MM IN 100MM.
6. MOLD# QFN/DFN/MIS6X4X0.75/0.85.
7. ALL DIMS IN MM.
8. BAN TO USE THE ENVIRONMENT-RELATED SUBSANCES OF JCET PRESCRIBING.

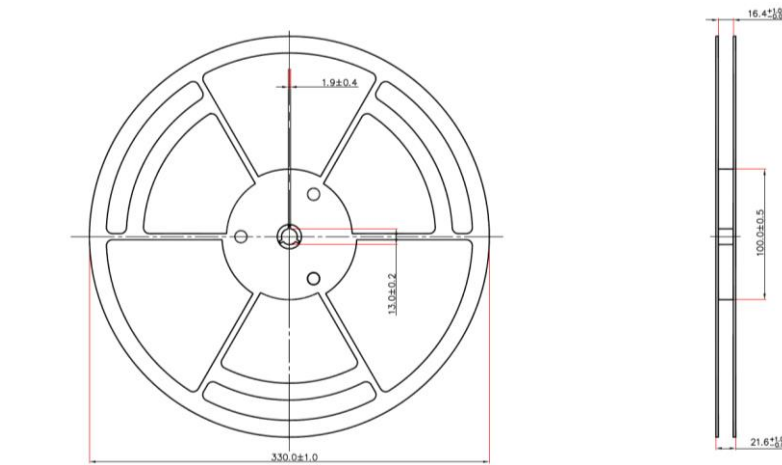

NOTES:

1. 2500 UNITS PER TRAY.
2. COLOR: WHITE.
3. ALL DIM IN mm.
4. GENERAL TOLERANCE±0.25.
5. BAN TO USE THE ENVIRONMENT-RELATED SUBSANCES OF JCET PRESCRIBING.
6. THE DERECTION OF VIEW:

12. Land Pattern

Recommended land pattern

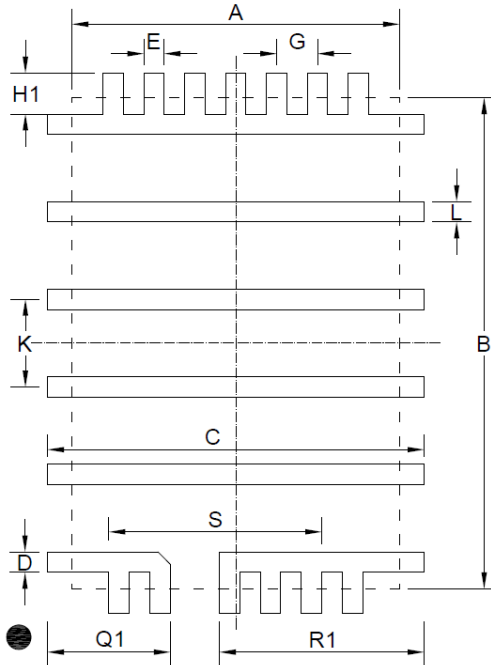

SYMBOL	MILLIMETER	NOTE
A	4.0	
B	6.0	
C	4.6	5X
D	0.25	3X
E	0.25	13X
G	0.5	10X
H1	0.5	13X
K	1.07	6X
L	0.25	4X
R1	2.5	
Q1	1.5	
S	2.6	

Recommended Stencil drawing

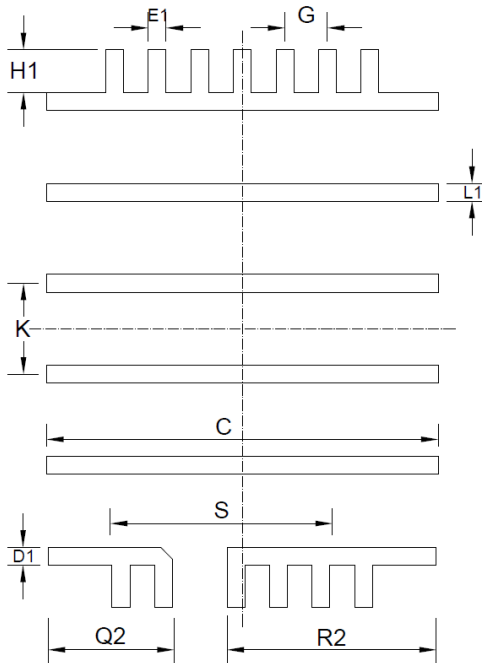

SYMBOL	MILLIMETER	NOTE
C	4.56	5X
D1	0.21	3X
E1	0.21	13X
G	0.5	10X
H1	0.5	13X
K	1.07	6X
L1	0.21	4X
R2	2.46	
Q2	1.46	
S	2.6	

13. Revision history

Major changes since the last revision

Revision	Date	Description of changes
1.0	2024-02-28	Version 1.0 release.
1.1	2025-03-17	1. Update Continuous current in table 4; 2. Update SOA in Fig.17.

Important Notice

The information provided in this document is intended as a guide only and shall not in any event be regarded as a guarantee of conditions, characteristics or performance. Innoscence does not assume any liability arising out of the application or use of any product described herein, including but not limited to any personal injury, death, or property or environmental damage. No licenses, patent rights, or any other intellectual property rights is granted or conveyed. Innoscence reserves the right to modify without notice. All rights reserved.